

SWISS POWER

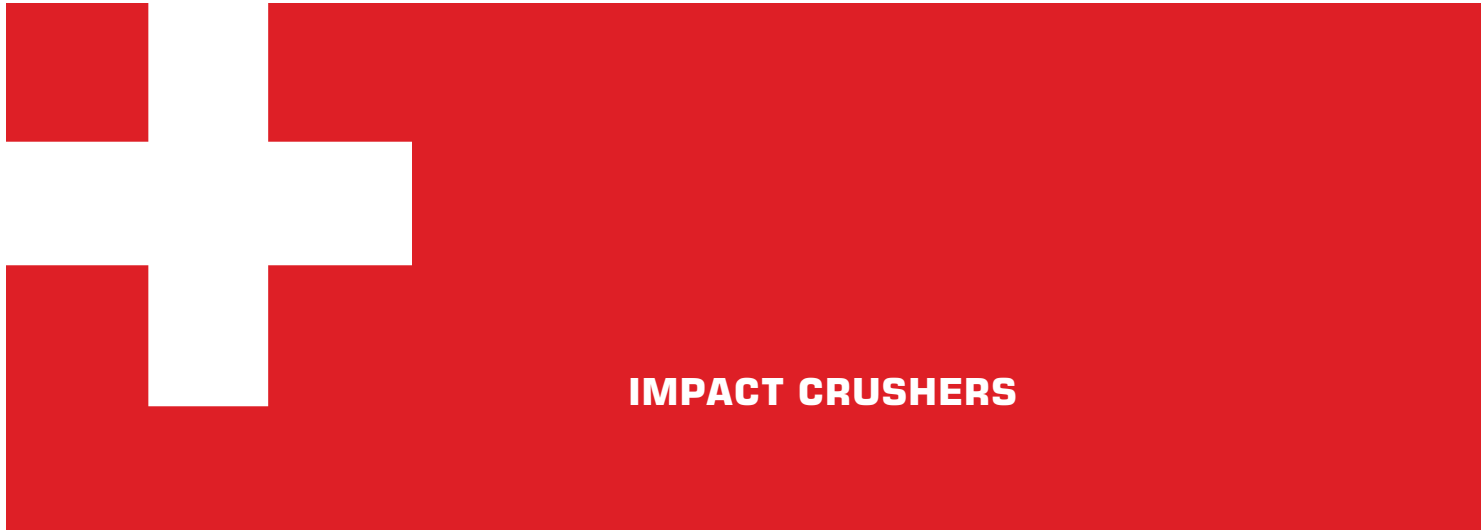

IMPACT CRUSHERS

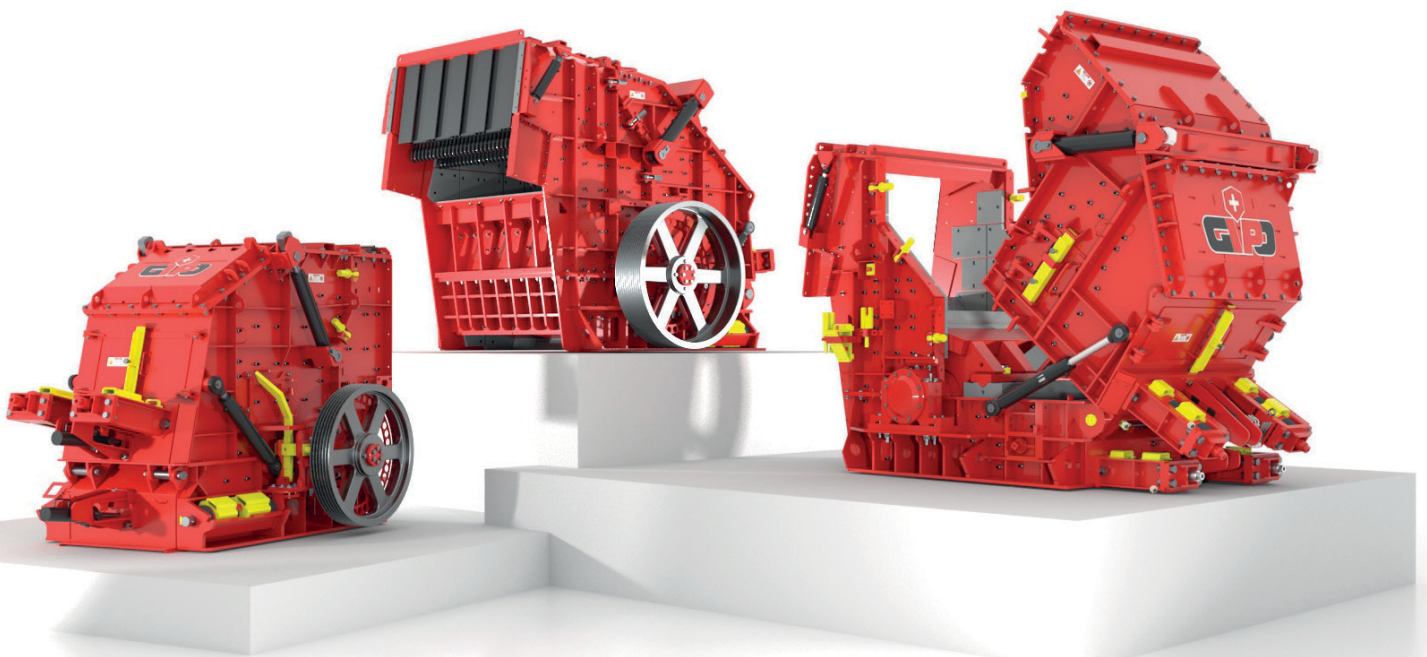

IMPACT CRUSHERS – PROVEN STRENGTH



The impact crushers from GIPO AG impress due to their very varied range of applications at temperatures from -50 °C to +55 °C. Heavily steel-reinforced concrete, asphalt, building rubble, as well as natural stone (granite, basalt, limestone) and glass can be crushed effortlessly. The impact crushers from GIPO are characterised by unmatched performance, durability and very straightforward operation.

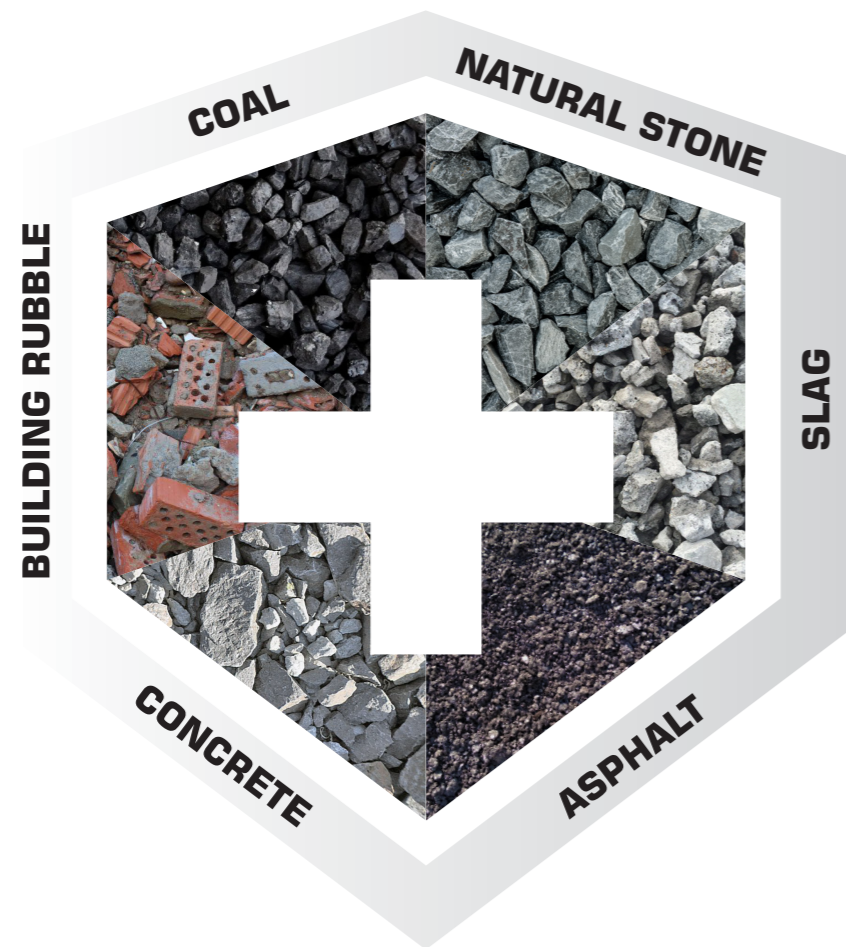

“ PERFECT CRUSHING FOR ALL APPLICATIONS ”

VERSATILE – RELIABLE – POWERFUL

Reliability and performance are the top priorities at GIPO AG. Thanks to our many years of experience, we have been able to continually improve and further develop the GIPO impact crusher so it is even more efficient. The crusher is particularly easy to operate due to the adjustment of the crushing gap opening is hydraulic and can be undertaken in the shortest possible time. Inspection doors are fitted to the crusher housing for monitoring the interior of the crusher. The hydraulic opening of the housing means that the impact bars, the impact plates and all other wearing parts can be replaced quickly without problems.

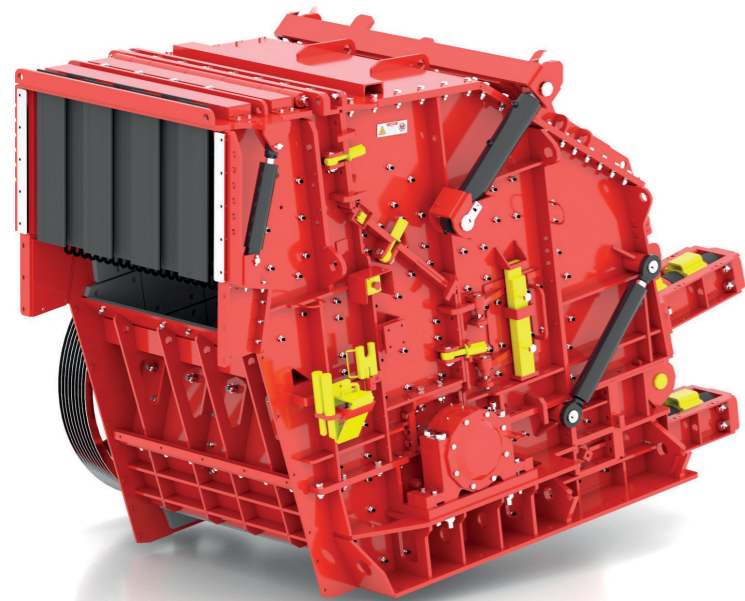
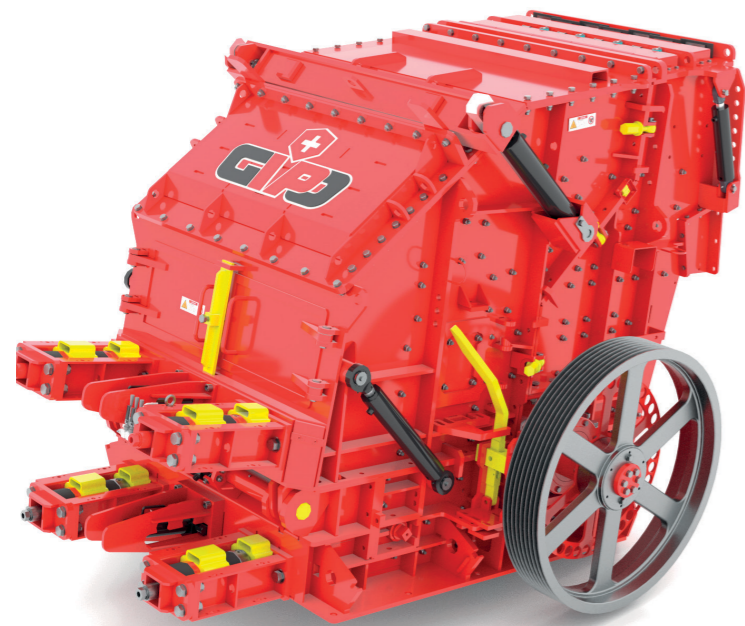

“UNIVERSAL SOLUTION”

GIPO impact crushers are ideal crushing tools for a wide range of applications. The broad product range covers every need.



FREDDY GILLIS
GM RECYCLING

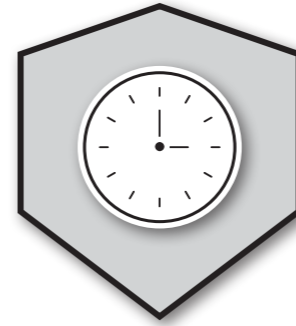

DURABLE

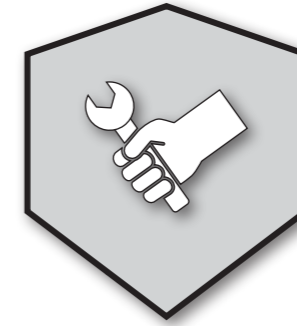

EASY TO OPERATE



POWERFUL

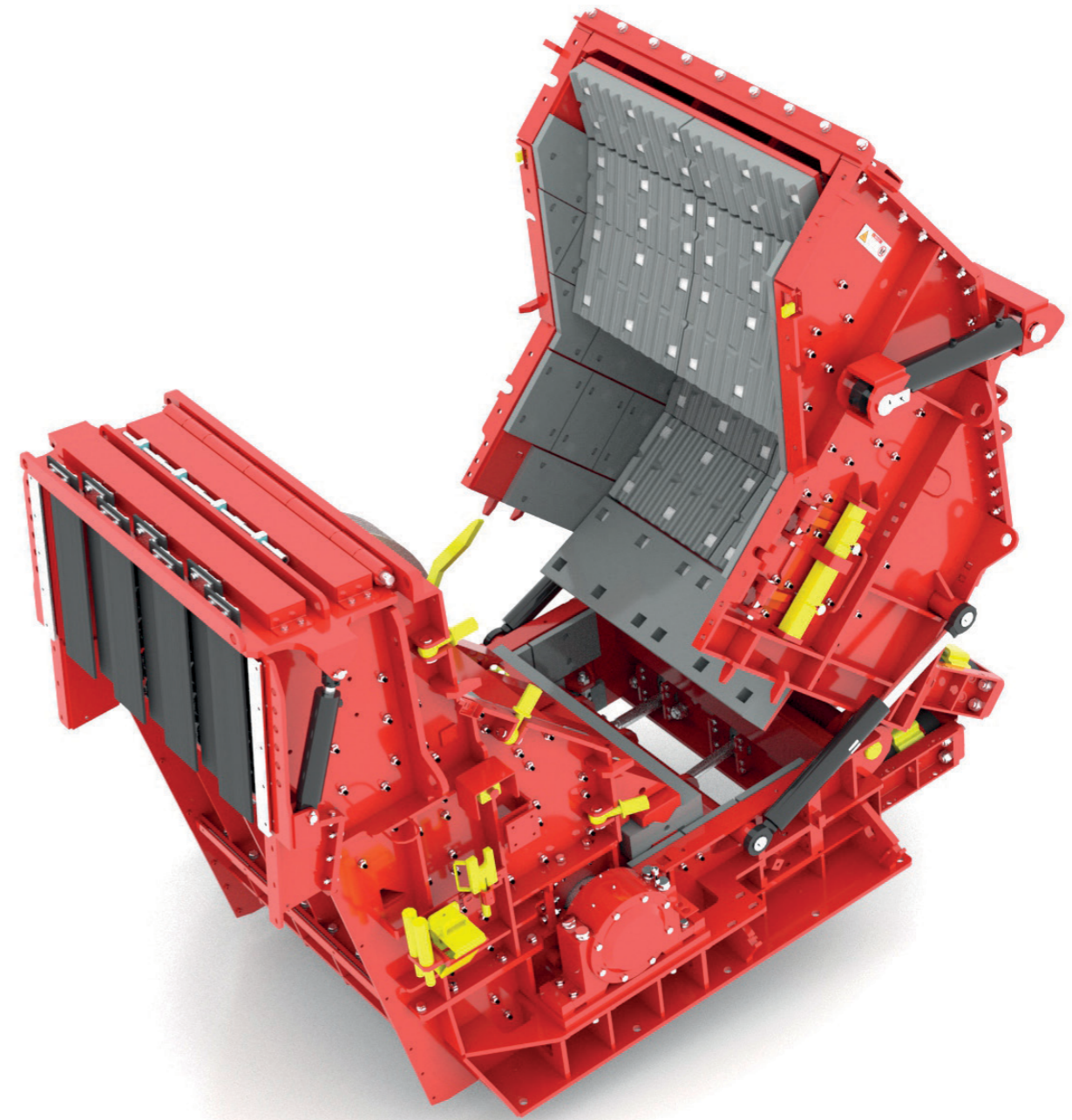

The hydraulic opening of the impact mill provides a high level of serviceability and safety.

UNCOMPLICATED – STRAIGHTFORWARD – COMPACT

The impact crusher P 090 is based on the proven universal impact crushers and meets the demand for compacter, smaller crushing systems. The Innovation P 090 with fixed crusher inlet and integrated crusher outlet box is therefore the ideal unit for a very wide range of applications with very limited space.

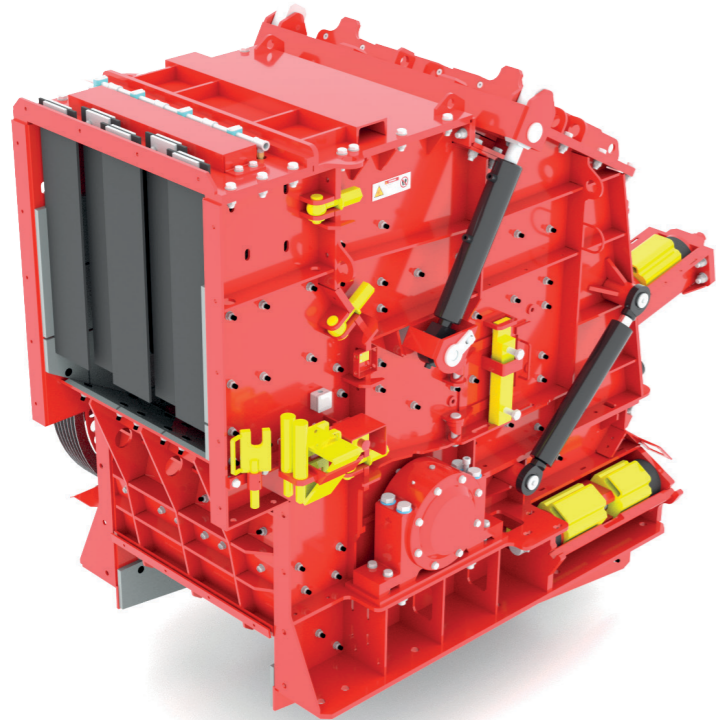

"MAXIMUM POWER – MINIMUM FORMAT"

With the GIPO P 090 impact crusher, GIPO AG has created a powerful, efficient solution that impresses with its reliability and performance in every application area.



PATRICK VIEUX
GIPO AG

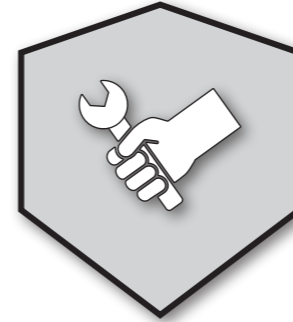

DURABLE

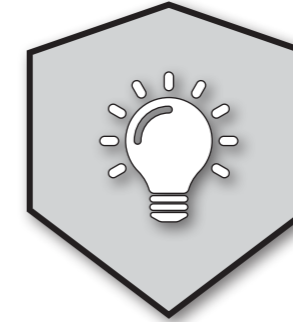

INNOVATIVE



POWERFUL

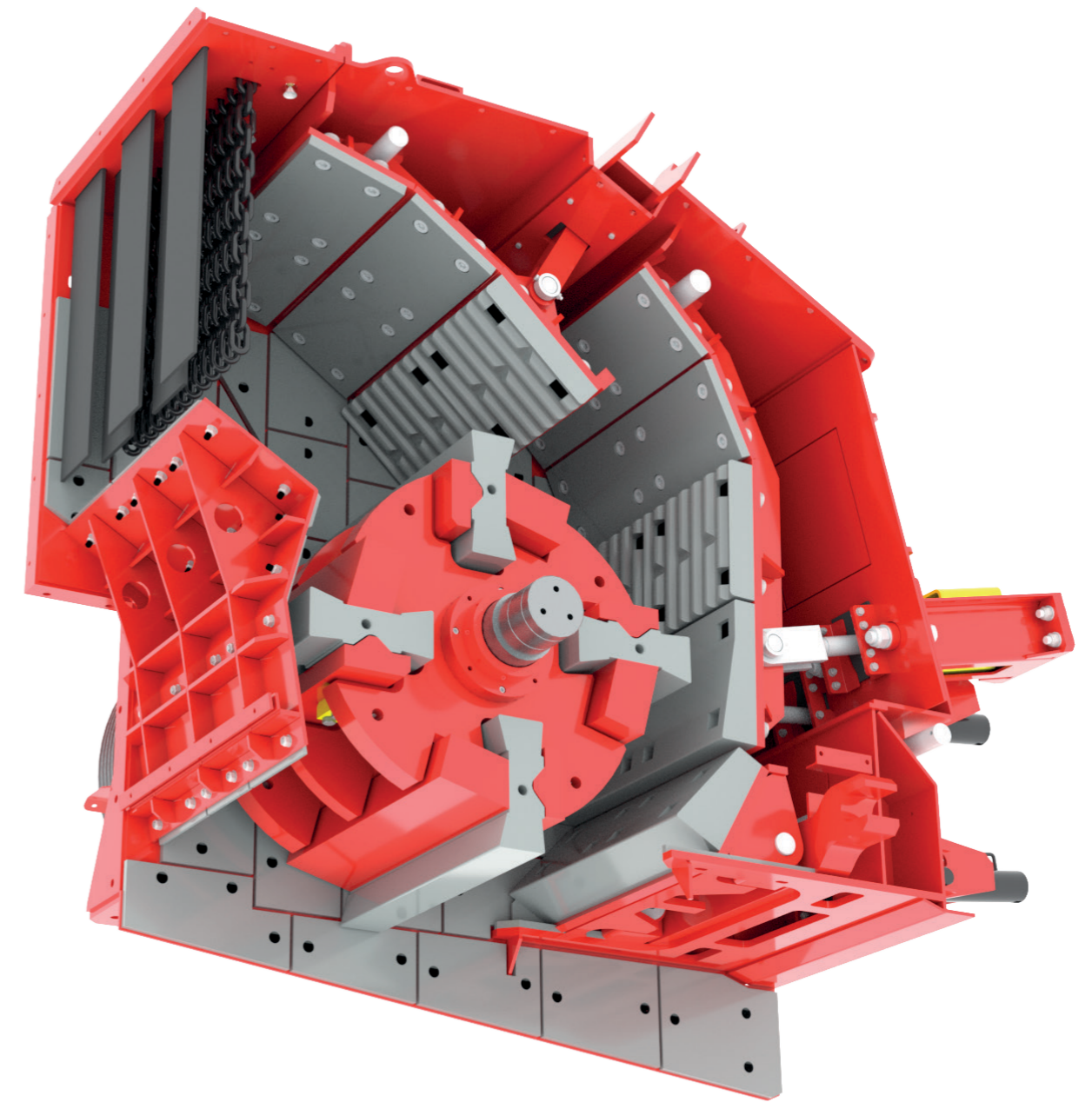

The GIPO impact crusher with integrated crusher outlet box and fixed inlet.



1

TOP IMPACT ARM

Hard knocks on the pre-crushing arm are straightforwardly absorbed using the hydraulic spring system.



4

CHAIN COVER

Straightforward hydraulic adjustment of the inlet opening to increase its size for processing maximum sizes. The chain curtain prevents material flying back.

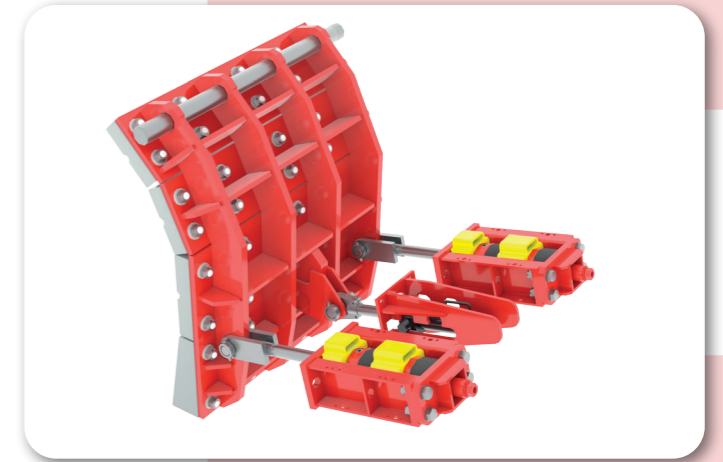
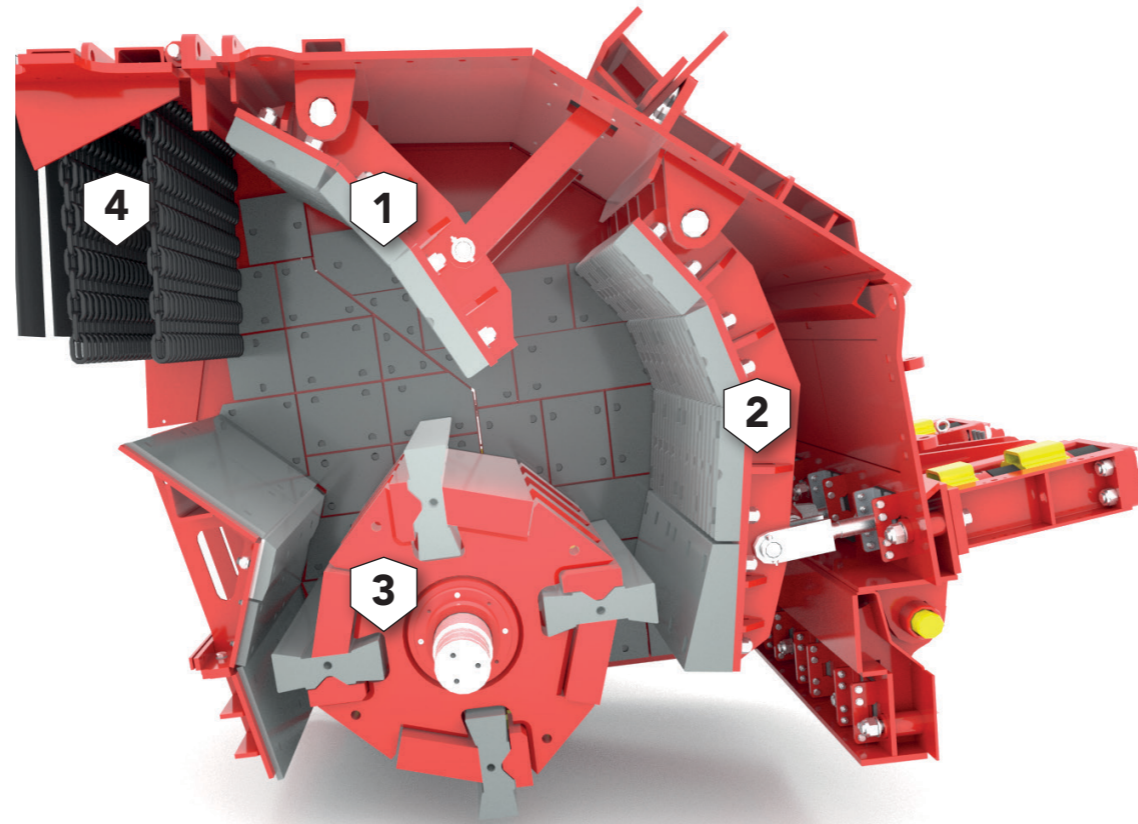

2

BOTTOM IMPACT ARM

The bottom arm can be operated straightforwardly, very quickly and safely using the hydraulic crushing gap adjustment. The robust, reliable elastomer system guarantees the production of the required final particle sizes, even under the toughest conditions.

ROTOR BEARING

The very generously dimensioned rotor bearing is specially designed for the highest loads.

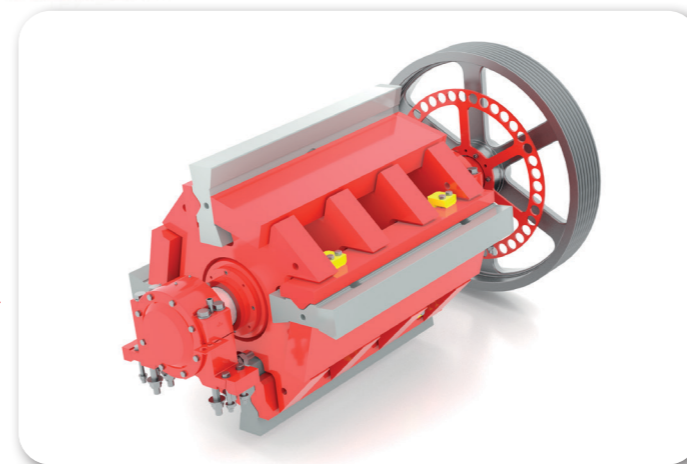
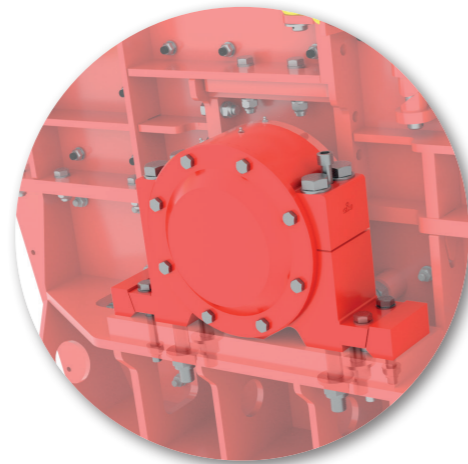

3

IMPACT ROTOR

The impact rotor ensures a high throughput with proven resilience to larger foreign objects.

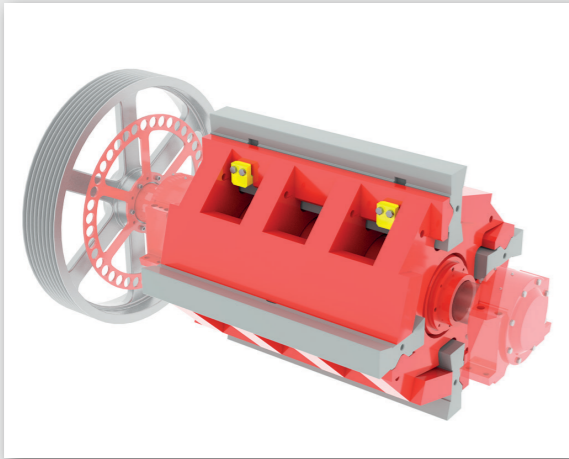

OPEN VARIANT

- Suitable for all applications
- Geometry is designed for low wear and highest throughput
- Proven system for impact bar fastening

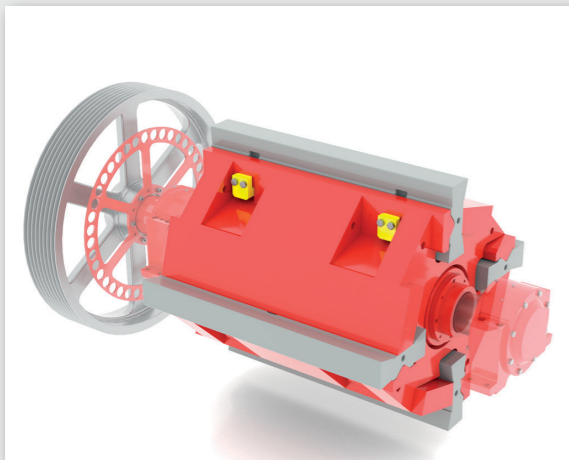

CLOSED VARIANT

- Smaller portion of oversize material
- Special geometry for hard use
- Less canting of foreign objects
- Additional weight for more impact force and lower drive power

IMPACT ROTOR

- Manufactured in a special plate structure with hard-wearing coating
- Accurately machined on CNC machines
- Ensures a high throughput with proven resilience to larger foreign objects
- Rotor shaft fastened in generously dimensioned self-aligning roller bearings on specially designed bearing block

GIPO AG offers various impact rotor designs to enable processing of all feed materials as efficiently as possible. Along with the standard products listed, on request we can also manufacture bespoke designs.



HYDRAULIC PIN LOCKING

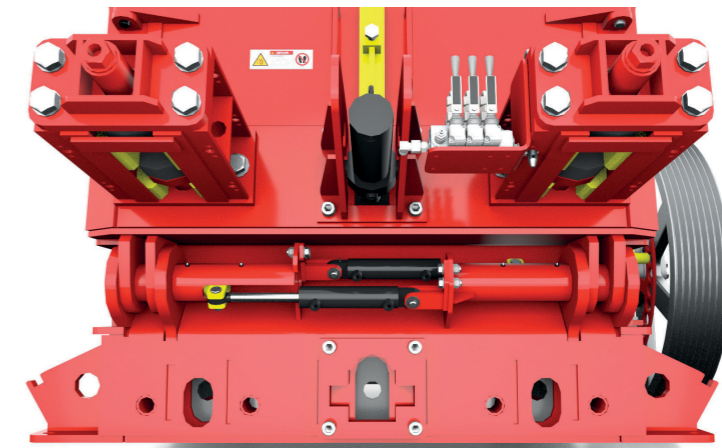

Operation directly at the impact crusher provides the best possible overview during assembly.

“QUICK WEIGHT REDUCTION”

The hydraulic pin locking makes possible quick disassembly to reduce the transport weight.



MARCO CAMMARATA
GIPO AG

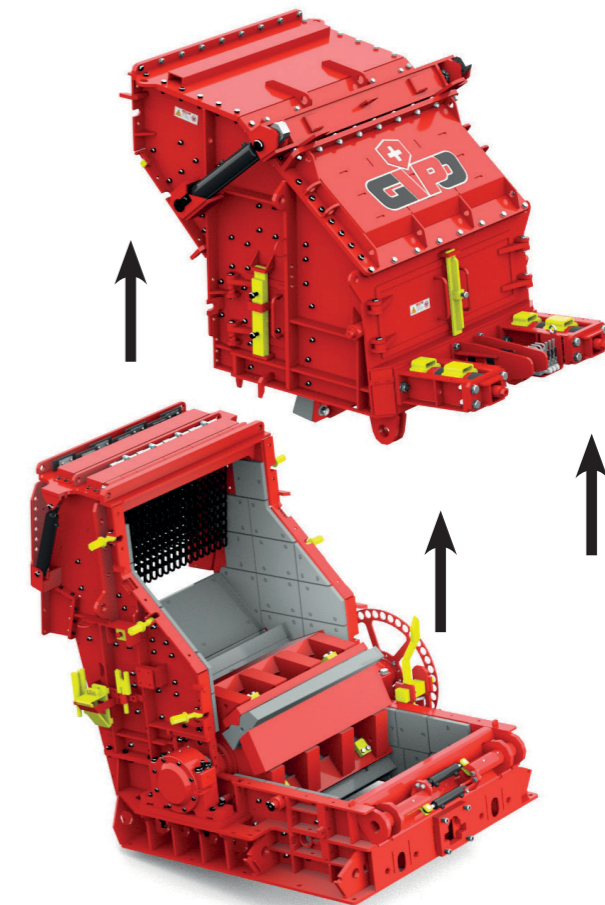

Straightforward replacement of the wearing parts thanks to quick disassembly of the upper part of the impact crusher as well as weight reduction for efficient, straightforward transport.





MAIN FEATURES

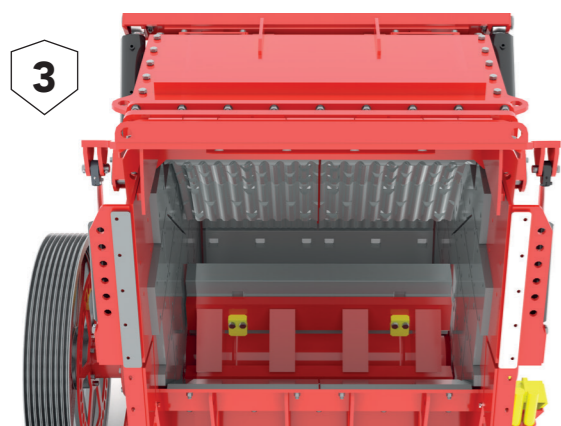
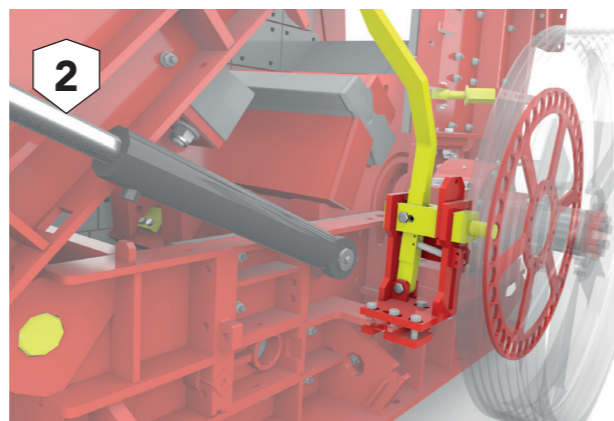
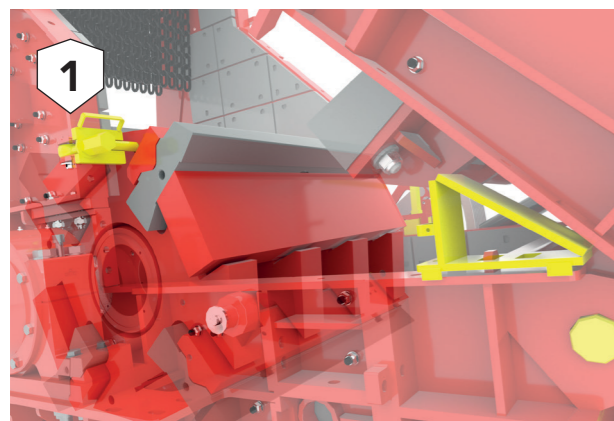

1 HINGED PART RESTRAINT

With the aid of the stop wedge and locking pin, the open upper part of the impact crusher and the rotor are secured enabling unhindered working in the interior.

2 ROTOR ANTI-ROTATION RESTRAINT

In addition, the mechanical pin locking system engages as the impact crusher is opened. This system provides additional safety while opening the impact crusher.

3 WEARING LINING

The lining of the impact mill with high-alloy cast manganese steel guarantees minimum wear with maximum performance.

4 WATER SPRAYING

By spraying already before crushing, suppression of the formation of dust can be improved.

HYDRAULICS

- Latest hydraulics for easy adjustment of the impact walls
- Safety gap adjustment for the bottom impact wall
- Opening of the entire crusher housing
- Adjustment to increase the size of the crusher inlet

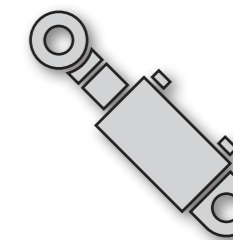

CRUSHER HOUSING

- Constructed in proven multi-piece box system
- Welded, weight-saving, torsionally stiff design
- Lower part of crusher with robust, CNC-machined rotor bearing

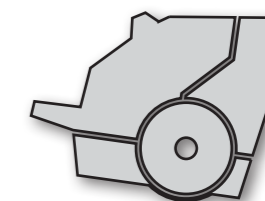

WEARING PARTS

- High-alloy cast high-carbon manganese steel – quality for special applications
- Also with ceramic inserts
- Lining of the side walls with highly wear-resistant, individually replaceable high-carbon steel plates
- Choice of impact plate or impact bar design for impact arms

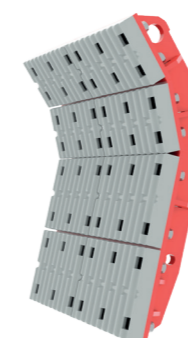
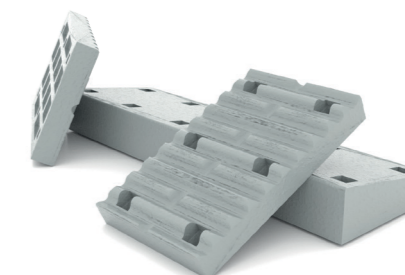

Impact plate design



Single impact bar design



Double impact bar design

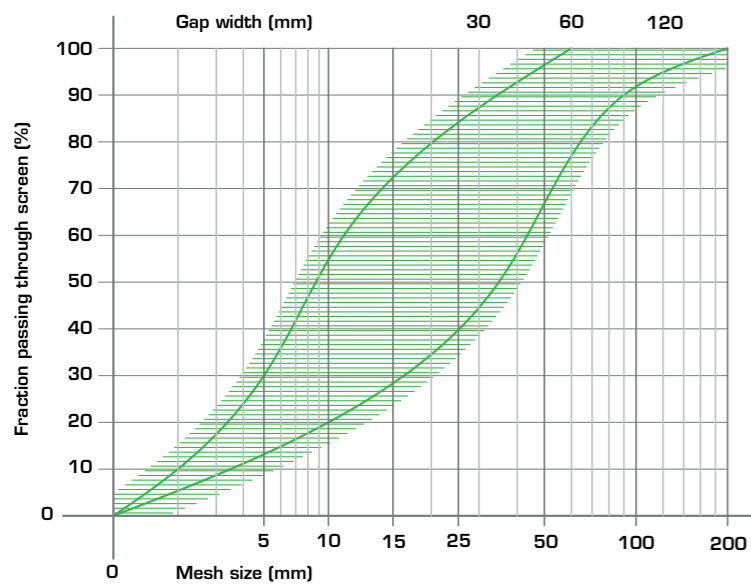
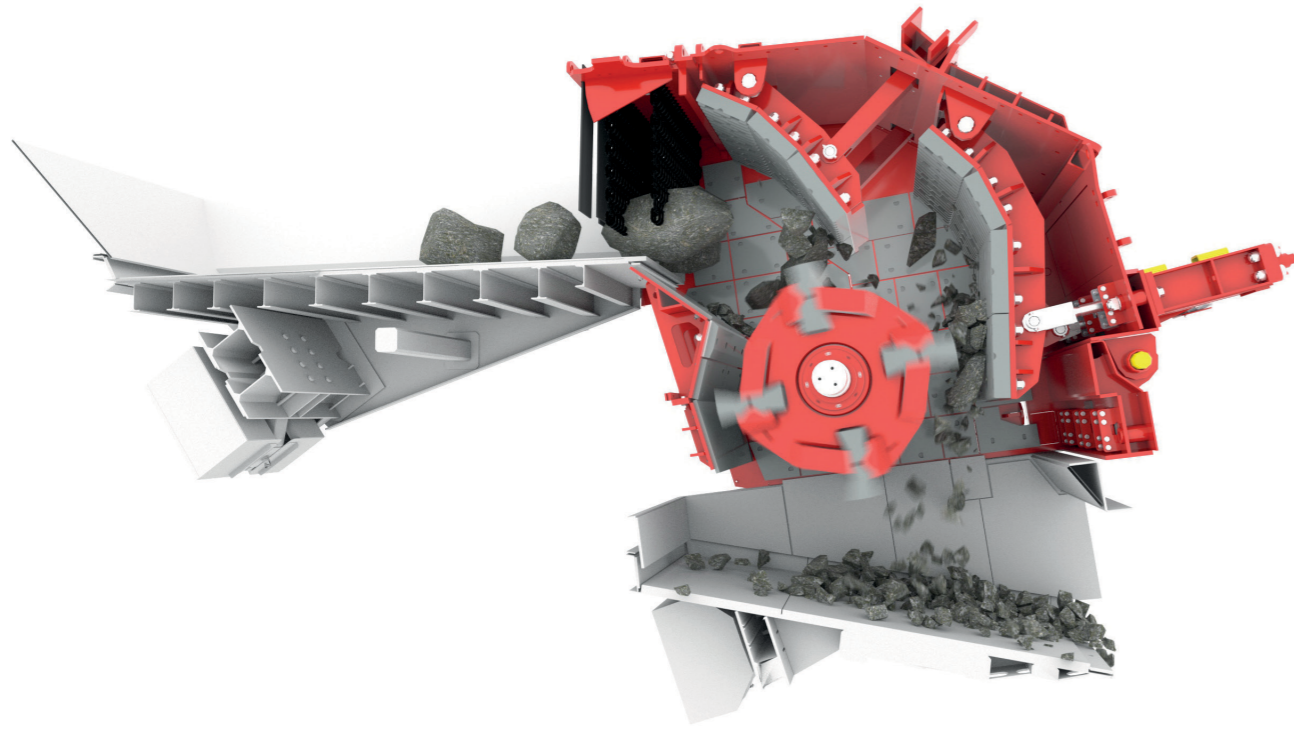

Primary impact crusher

- Pre-crusher for soft and medium-hard rock
- Suitable for large, bulky feed material
- Steel reinforcing is not a problem thanks to the large volume pathway and no interfering edges
- High performance with optimal degree of crushing
- Cubic end product with medium-high portion of sand

** Screening curve: the particle distribution is dependent on the feed material (feed material lump size, particle size distribution/portion of fine material), discharge of pre-screen material, the required final particle size, optimal operation of the plant and feeding, as well as the correct adjustment of the plant.*

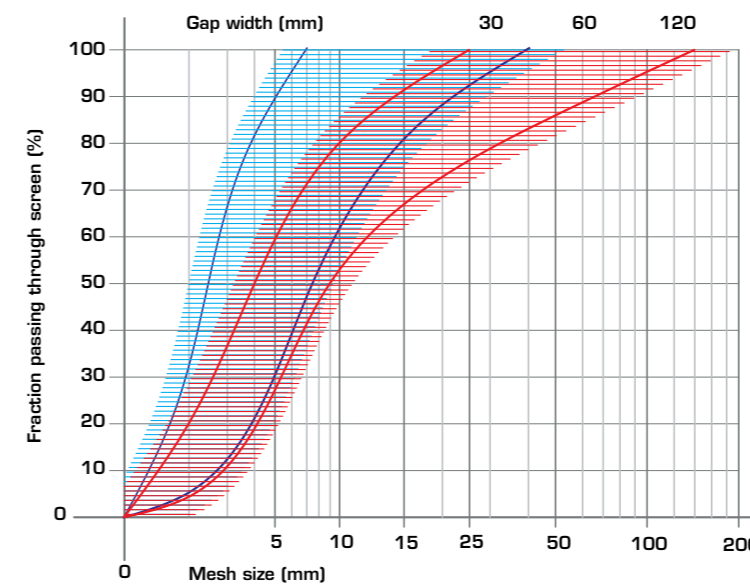
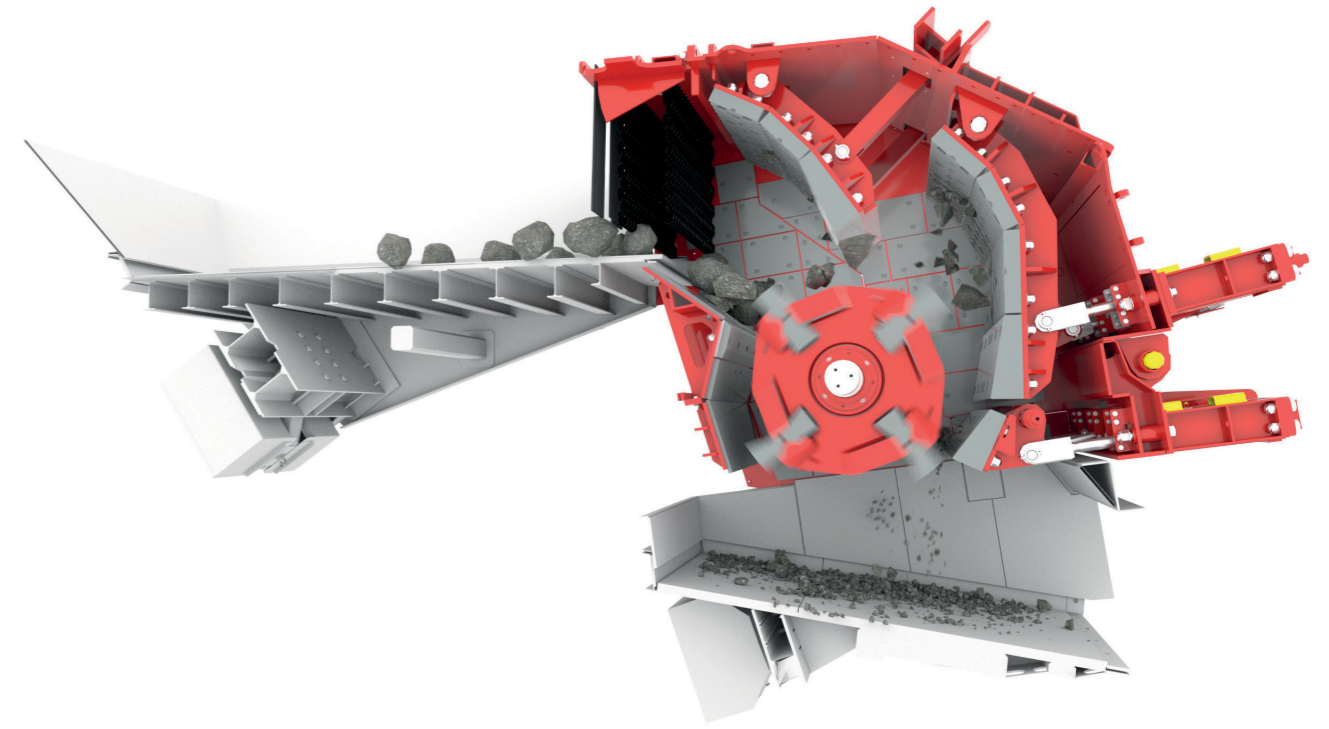

Secondary impact crusher

- Pre-crusher and post-crusher for all rock
- Suitable for medium-sized feed material
- Cubic end product with high portion of sand

Crushing adjusting mechanism

- Post-crusher for pre-crushed rock
- Cubic end product with very high portion of sand

** Crushing performance: the crushing performance is dependent on the characteristics of the feed material (condition, abrasiveness, etc.), the feed material lump size, particle size distribution/screening curve (portion of fine material), discharge of pre-screen material, the required final particle size, optimal operation of the plant and feeding, as well as the correct adjustment of the plant.*

CRUSHING BEHAVIOUR

Various settings on the GIPO impact crusher can be used to change the particle size distribution. The crushing curve for the end product can be adjusted specifically using the two independently hydraulically adjustable impact arms. GIPO AG also offers alternatives from proven impact plates to continuous impact bars for the impact arms. The continuous adjustment of the rotor speed helps you to produce the product required in every application.

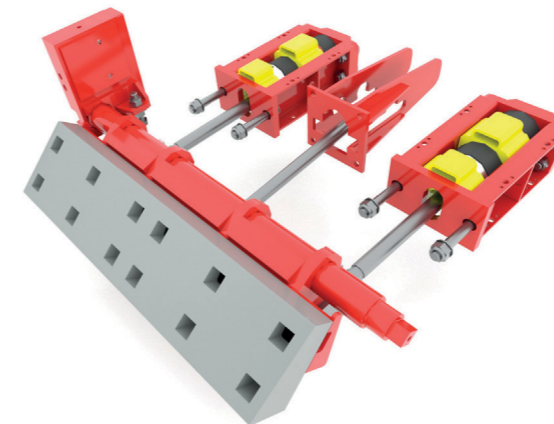

CRUSHING ADJUSTING MECHANISM

The degree of crushing is further reduced by the easy-to-install crushing adjusting mechanism, which results in a higher portion of fine particles.



IMPACT BARS – WEAR-RESISTANT AND POWERFUL

The cost-effective usage of the impact bars is influenced by many factors. Thanks to today's combination with ceramic, the bars are becoming increasingly wear-resistant and powerful, which in turn signifies a considerably longer service life with long servicing and replacement intervals.

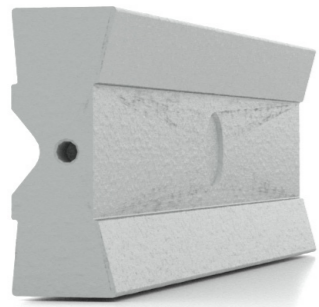

MANGANESE

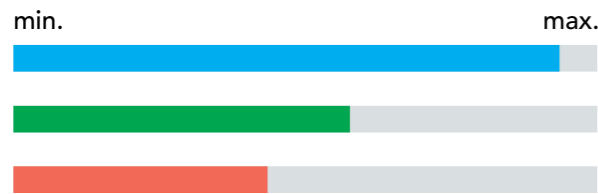

MARTENSITE-CERAMIC

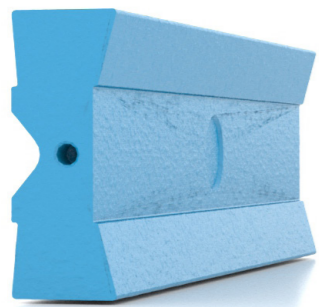
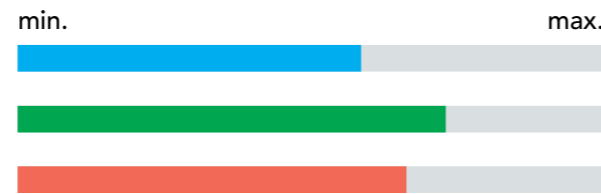

MARTENSITE-CERAMIC PLUS

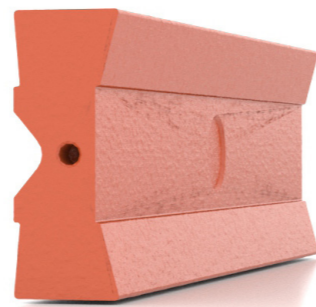

CHROMIUM

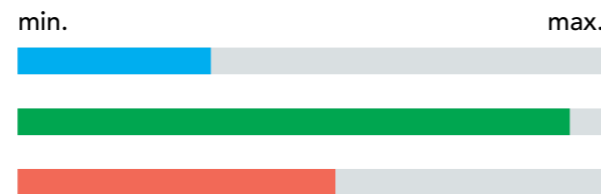

■ Impact resilience

■ Wear resistance

■ Service life



IMPACT BARS – CHARACTERISTICS

MATERIAL TYPE	CHARACTERISTICS	APPLICATION
MANGANESE	<ul style="list-style-type: none"> - High impact resilience - Extraordinary capacity for strain 	<ul style="list-style-type: none"> - Low abrasiveness, e.g. limestone - Very large feed material size - For high portion of uncrushable objects in the feed material e.g. iron
MARTENSITE-CERAMIC	<ul style="list-style-type: none"> - Consistent wear resistance - Reduced wear 	<ul style="list-style-type: none"> - Secondary crushing stage - Universal recycling - For abrasive natural stone or river gravel
MARTENSITE-CERAMIC PLUS	<ul style="list-style-type: none"> - Optimised service life (+40% compared to martensite-ceramic) - Reduced servicing - Stable wear profile - Increased productivity - Large feed material size up to 700 mm 	<ul style="list-style-type: none"> - Primary and secondary crushing stage - Universal recycling - Building rubble recycling with high portion of iron - Concrete - Natural stone - Granite - Diabase
CHROMIUM	<ul style="list-style-type: none"> - Maximum hardness - Extremely wear-resistant - Feed material size up to 300 mm 	<ul style="list-style-type: none"> - Secondary crushing stage - Natural stone or river gravel - No iron portion - Hard rock - Pre-crushed material

* The values stated in relation to the crushing performance and feed material lump size are heavily dependent on the characteristics of the feed material (condition/abrasiveness, particle size distribution, portion of fine material, etc.), the required final particle size, optimal operation of the plant and feeding, as well as the correct adjustment of the plant.

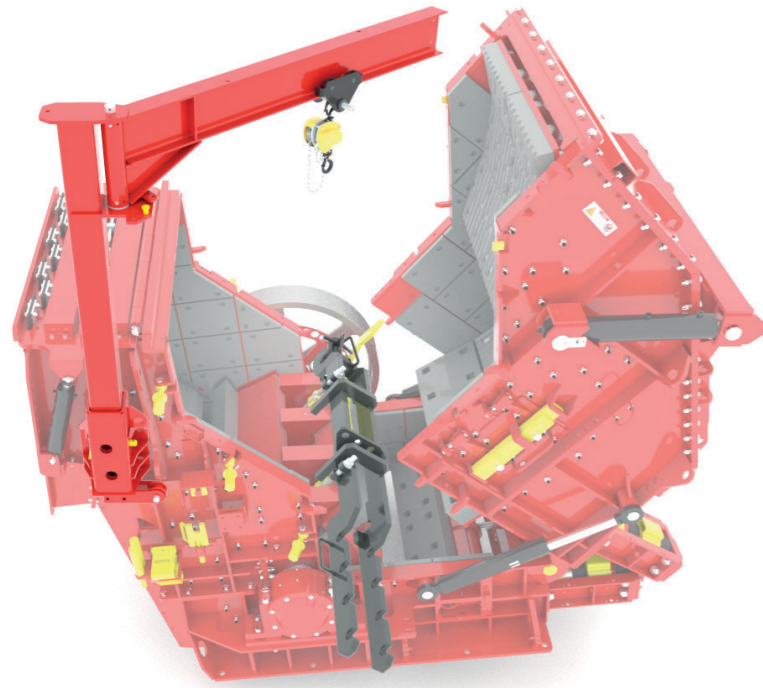

The swivelling crane makes it possible to work without additional lifting equipment.

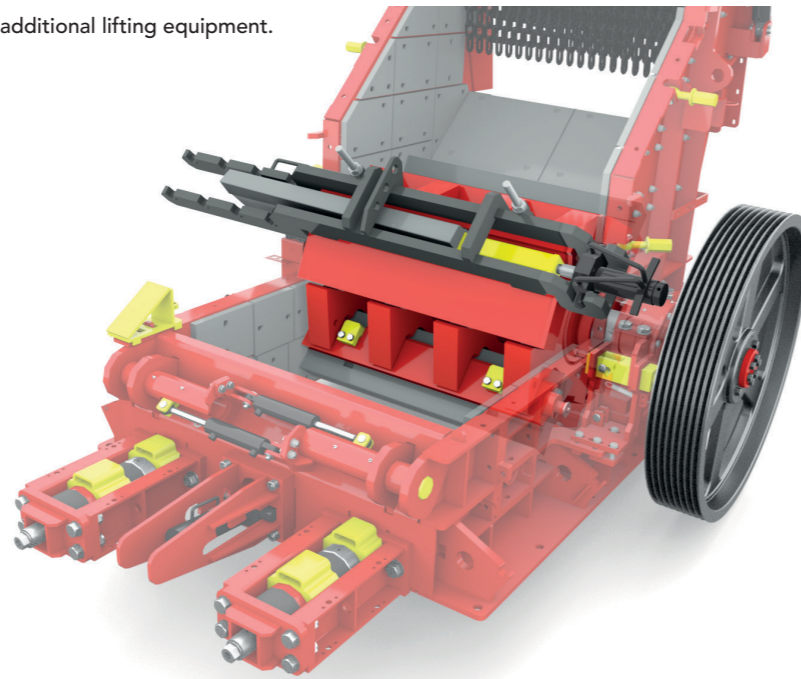

The extracting device ensures a high level of safety during servicing work.

IMPACT BAR EXTRACTING DEVICE / SWIVELLING CRANE

The extracting device significantly reduces the downtime and ensures a high level of safety during servicing work on the impact bars.

Optionally, operation can be further expanded with a swivelling crane that makes it easier to replace wearing parts and impact bars.



TECHNICAL DATA SHEET

Impact crusher	Rotor width approx. (mm)	Rotor Ø (impact circle Ø) approx. (mm)	Speed (rev/min) peripheral speed approx. 25-42 (m/s)	Inlet opening (WxH) Size of inlet opening can be increased hyd. approx. (mm x mm)	Drive power approx. (kW)	Feed material lump size approx. (mm x mm x mm)	Final particle size approx. (mm)	Performance approx. (t/h)	Total weight approx. (t)	Total weight with crushing adjusting mechanism approx. (t)	Operating weight approx. (t)
P 090	850	1,100	650	870x800	110	500x600 x800	0-200	200	9.5-10.0 10.5-11.0		12.5
P 101	950	1,100	650	970x800	160	600x600 x800	0-200	250	10.0-10.5 11.0-11.5		12.0
P 100	950	1,200	650	970x800 970x920	132	600x800 x1,000	0-200	250	13.0-13.5 14.0-14.5		16.0
P 111	1,050	1,200	650	1,070x800 1,070x920	200	700x800 x1,000	0-200	300	13.5-14.0 14.5-15.0		18.0
P 131	1,250	1,200	650	1,270x800 1,270x920	200	900x800 x1,100	0-200	400	16.0-16.5 17.0-17.5		20.0
P 130	1,250	1,300	600	1,270x925 1,270x1,100	250	900x900 x1,100	0-200	500	18.5-19.5 19.5-20.5		23.0
P 150	1,480	1,300	600	1,470x925 1,470x1,100	355	900x1,000 x1,300	0-200	600	22.0-23.0 23.5-24.5		27.0
P 170	1,650	1,300-1,400	600	1,670x925 1,670x1,100	400-450	900x1,000 x1,500	0-200	700	24.0-25.5 25.5-27.0		30.0

Impact crusher	External height A approx. (mm)	External width B approx. (mm)	External length C approx. (mm)
P 090	2,400	1,800	3,000
P 101	2,400	1,900	3,000
P 100	2,300	2,000	3,500
P 111	2,300	2,100	3,200
P 131	2,400	2,300	3,500
P 130	2,600	2,400	3,700
P 150	2,600	2,600	3,700
P 170	2,600	2,800	3,700

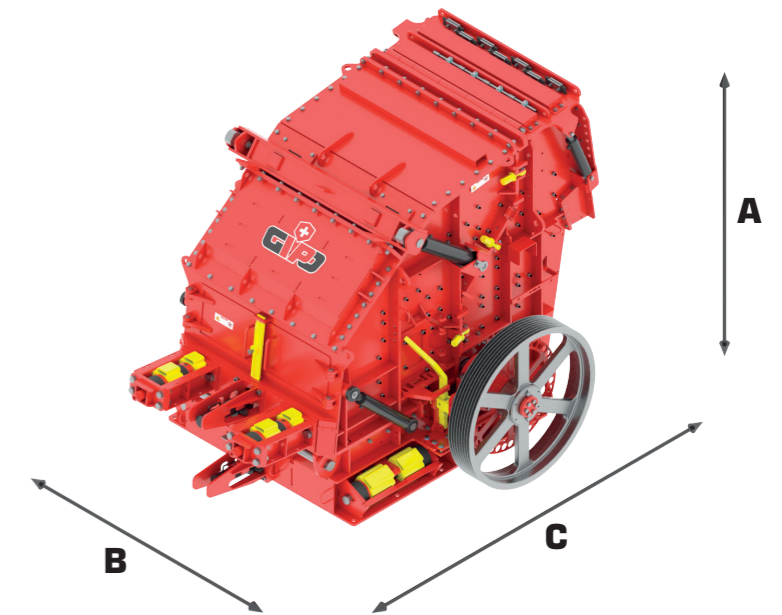

* The values stated in relation to the crushing performance and feed material lump size are heavily dependent on the characteristics of the feed material (condition/abrasiveness, particle size distribution, portion of fine material, etc.), the required final particle size, optimal operation of the plant and feeding, as well as the correct adjustment of the plant.





GIPO AG
Industriegebiet See, Zone C
Kohlplatzstrasse 15
CH-6462 Seedorf

T +41 41 874 81 10
info@gipo.ch
www.gipo.ch
Schweiz/Switzerland/Suisse



Figures and text are for information only and may include options.
Subject to technical change. Performance data are dependent on
the application conditions.

